

Note!

Please note that this image is a general representation of the product and may differ slightly from your product.

Note!

Please note that during storage and transportation, especially at high ambient temperature, some of the oil and grease used for assembling may leak and stain the packaging. This is in no way detrimental to the product, wipe off the excessive oil/grease with a cloth.

Note!

Before installing this product, check the contents of the kit. If anything is missing, please check an Öhlins dealer.

Kit Contents

Description	Part No	Pcs
Shock absorber	YA 315	1
Nut M8	00430-05	1
Screw 8x45	00432-05	1
Tool preload adjuster	03199-03	1
Sticker set "ÖHLINS"	10207-01	1
Owners manual road & track	07241-02	1

Warning!

Before installing this product, read the Öhlins Owner's Manual. The shock absorber is an important part of your vehicle and will affect the stability.

Shock Absorber for Yamaha Fazzio 125

YA 315

Mounting Instructions

MOUNTING INSTRUCTIONS

⚠ Warning!

It is advisable to have an Öhlins dealer install the shock absorber.

⚠ Warning!

If working on a raised vehicle, ensure it is securely supported so that it will not tip over.

👁 Note!

Before mounting this product clean the vehicle thoroughly.

👁 Note!

When working on this product, always see the Vehicle Service Manual for vehicle specific procedures and important data.

1

Put the motorcycle on the center stand so that the rear wheel barely touches the ground. Make sure the motorcycle is in a stable position.



2

Open the seat.

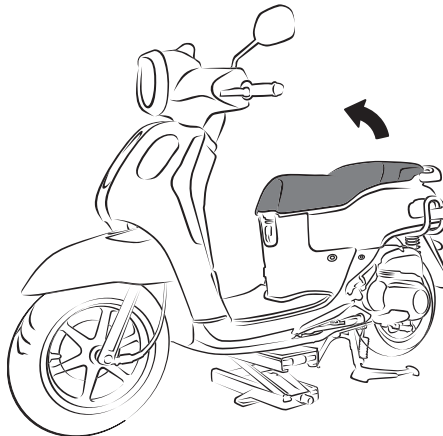

MOUNTING INSTRUCTIONS

3

Loosen the screws ①②③④ in order to remove the storage box.

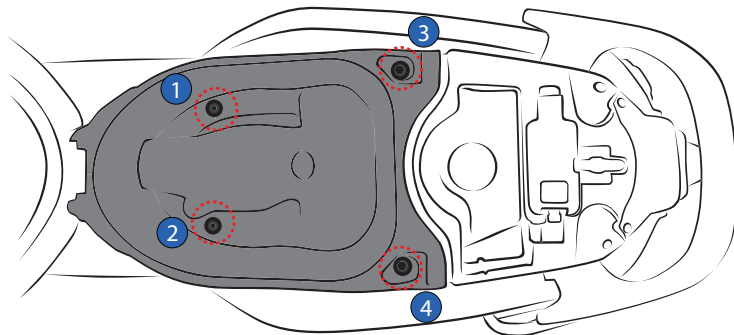

4

Remove the plastic coverⒶ

4.1

Loosen the screws ①② in order to remove tail light cover Ⓑ.

4.2

Remove the fuel tank cap.

4.3

Loosen the screws ③④⑤⑥ in order to remove the plastic fuel tank cover Ⓒ.
Reinstall the fuel tank cap (for safety)

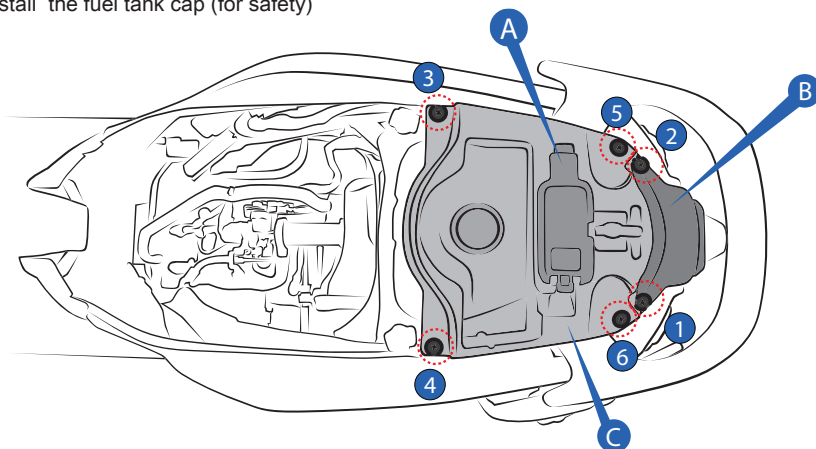

MOUNTING INSTRUCTIONS

5

Loosen the screws ①②③④ in order to remove the grab bar ⑤.

5.1

Loosen the screws ⑤⑥ in order to remove the taillight ⑥.

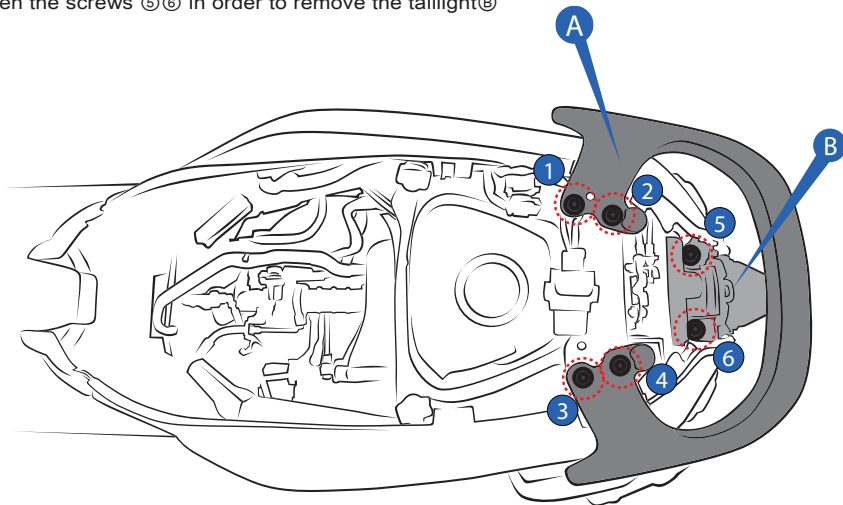

6

Loosen the screws ①② left and right side in order to access the push pin plastic ③④.

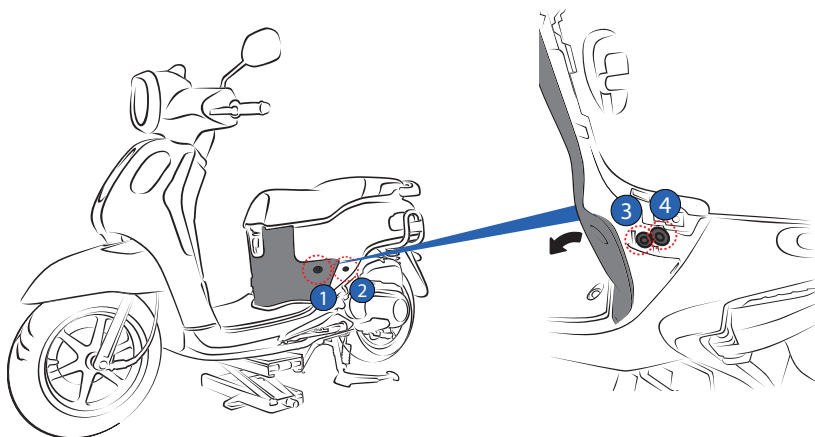

MOUNTING INSTRUCTIONS

7

Loosen the screws ①② in order to remove side rack.

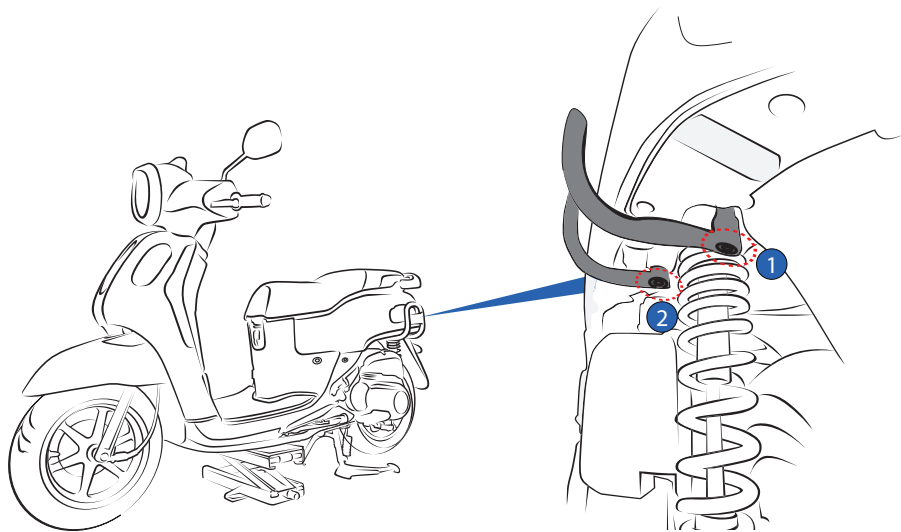

8

Loosen the screws ①②③④ left and right side in order to remove the fairing and taillight.

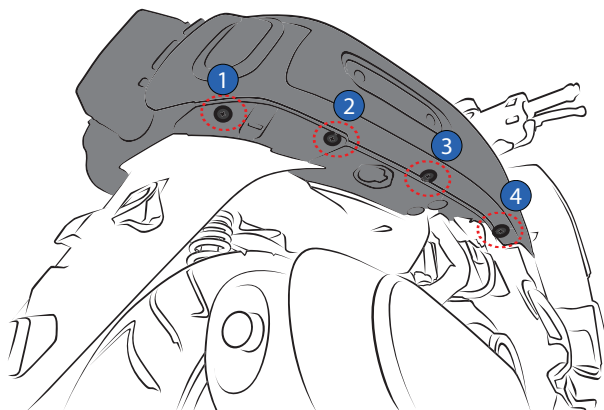

MOUNTING INSTRUCTIONS

9

Loosen the screws ①② in order to remove the standard shock absorber.

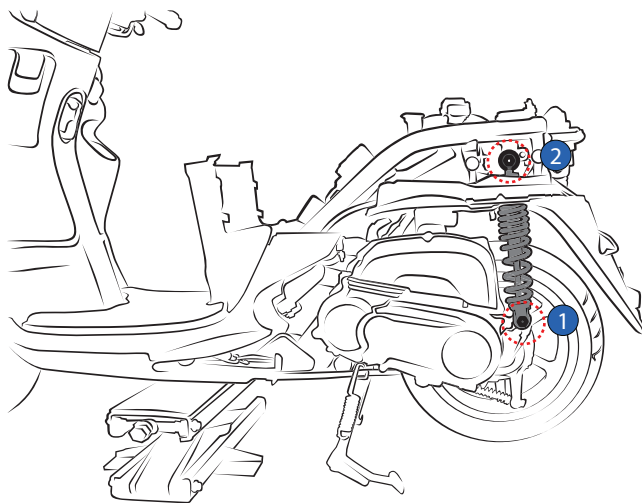

10

Install the Öhlins shock absorber by tightening the upper and lower mounting screw ①②. Tighten at torque value as specified in the vehicle service manual and reverse all procedure as necessary.

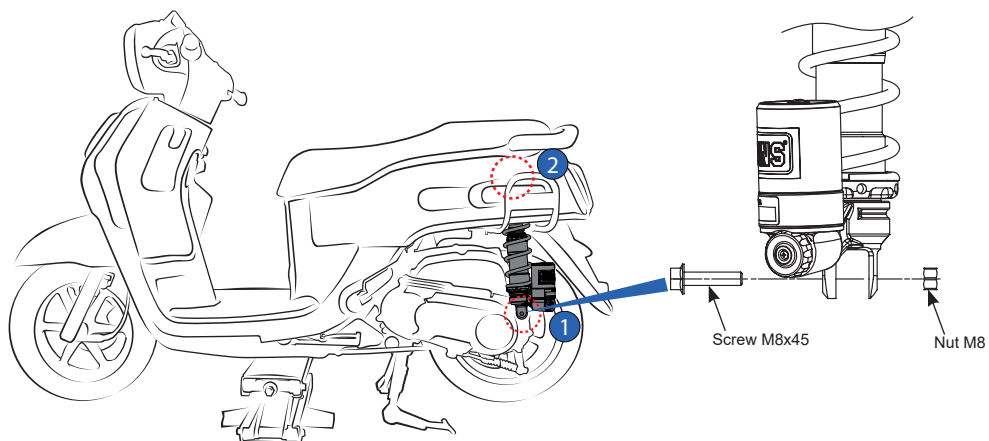

MOUNTING INSTRUCTIONS

This page intentionally left blank

ADJUSTMENTS

⚠ Warning!

Before riding, always make sure that the basic settings made by Öhlins are according to recommended Set-up Data. Read about adjustments and setting up in the Öhlins Owner's Manual before you make any adjustments. Contact an Öhlins dealer if you have any questions about setting up.

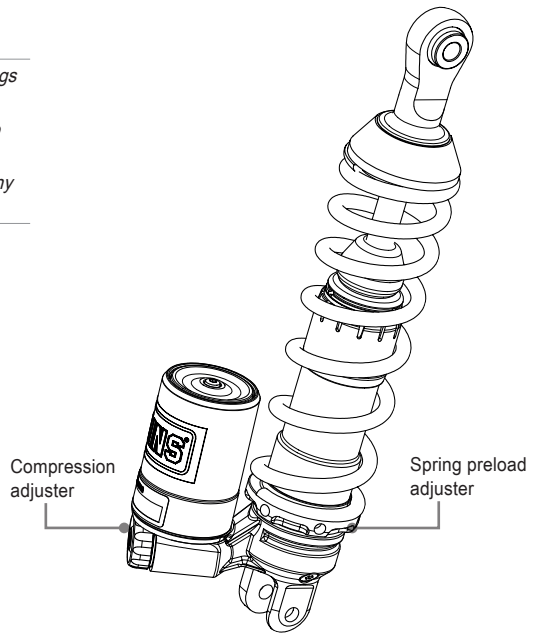

SET-UP DATA

Recommended set-up

Spring Preload..... 3 mm.
Compression adjuster..... 16 Clicks

Shock absorber data

Length 316.5 mm.
Stroke 84.5 mm.

Spring data

Installed Spring

Part No 66380-09
Free spring length 190 mm.
Spring rate Prog. 22-40 N/mm
Preload adj.range [1.5-15] mm.

👁 Öhlins products are subject to continuous improvement and development, therefore, although these instructions include the most up-to-date information available at the time of printing, minor updates may occur.

To find the latest information contact an Öhlins distributor. Please contact Öhlins if you have any questions regarding the contents in this document.

Part no. MI_YA 315 EN_0
Issued 2023-07-26

© Öhlins Asia Co. Ltd. All rights reserved. Any reprinting or unauthorized use without the written permission of Öhlins Racing AB is prohibited.

Öhlins Asia Co. Ltd
700/937 Moo5, Tambol Nongkhaga,
Amphur Phantong, Chonburi Province
20160 Thailand



www.ohlins.com