

Note!

Before installing this product, check the contents of the kit. If anything is missing, please check an Öhlins dealer.

Kit Contents

Description	Part No	Pcs
Shock absorber	HO 349	1
Screw M8x45	00432-05	1
Washer 8/20/0.5	63118-05	2
Nut M8	00430-05	1
Screw M6x20	05404-03	1
Washer 6.4/18/1.6	00426-04	1
Spacer eccentric	60049-06	1
Tool preload adjuster	03199-03	1
Sticker set "ÖHLINS"	10207-01	1
Owners manual road & track	07241-02	1

Note!

Please note that this image is a general representation of the product and may differ slightly from your product.

Note!

Please note that during storage and transportation, especially at high ambient temperature, some of the oil and grease used for assembling may leak and stain the packaging. This is in no way detrimental to the product, wipe off the excessive oil/grease with a cloth.

Warning!

Before installing this product, read the Öhlins Owner's Manual. The shock absorber is an important part of your vehicle and will affect the stability.

Shock Absorber for Honda Giorno+ 125

HO 349

Mounting Instructions



MOUNTING INSTRUCTIONS

⚠ Warning!

It is advisable to have an Öhlins dealer install the shock absorber.

👁 Note!

Before mounting this product clean the vehicle thoroughly.

⚠ Warning!

If working on a raised vehicle, ensure it is securely supported so that it will not tip over.

👁 Note!

When working on this product, always see the Vehicle Service Manual for vehicle specific procedures and important data.

1

Put the motorcycle on a work stand so that the rear wheel barely touches the ground. Make sure the motorcycle is in a stable position.

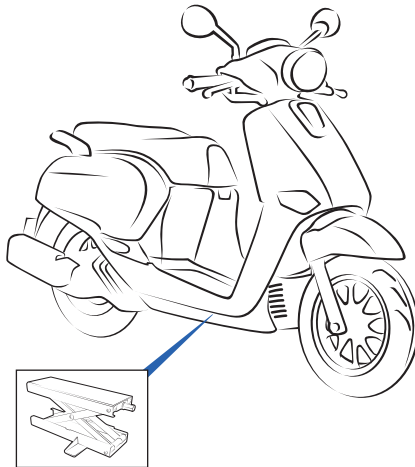

2

Open the seat by using the ignition key.

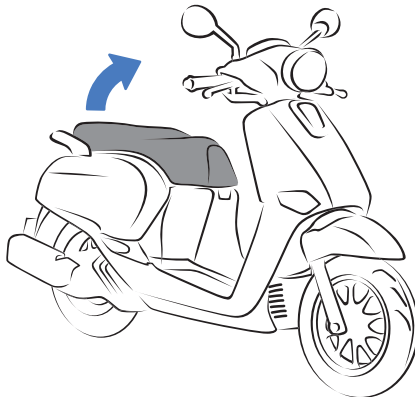

MOUNTING INSTRUCTIONS

3
Remove the storage box (A) by loosening the screws ①②③④ and plastic pins ⑤⑥⑦⑧⑨⑩.

3.1

Remove the grab bar (B) by loosening the screw ⑪.

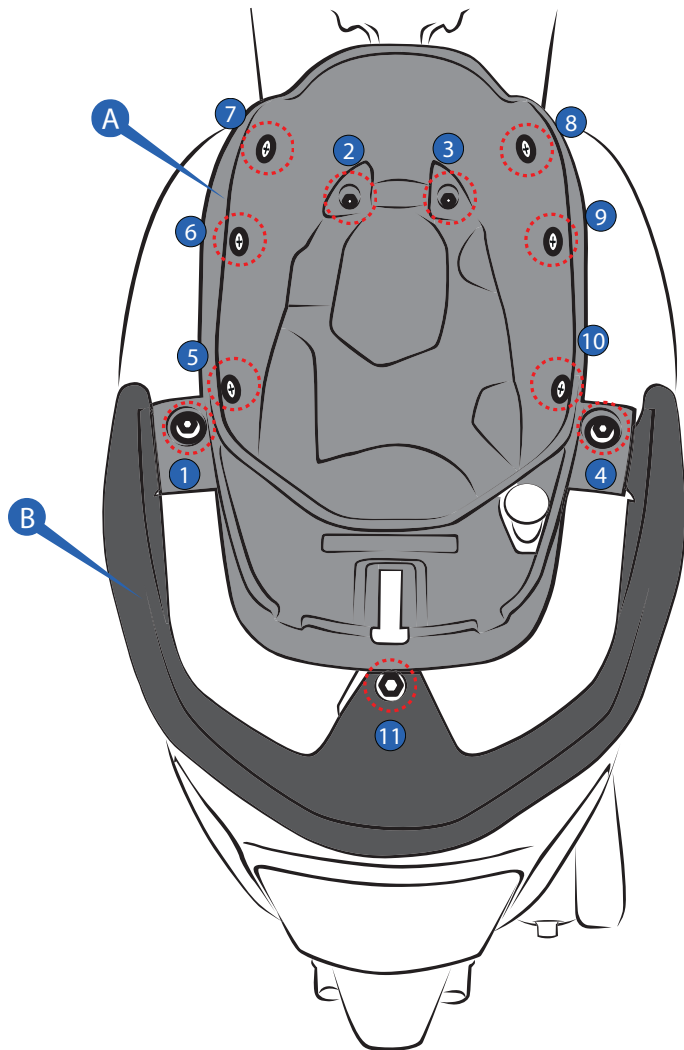

MOUNTING INSTRUCTIONS

4

Remove the center fairing (C) by loosening the screws ①②③④.

4.1

Remove the side fairing (D) by loosening the plastic pins ⑤⑥⑦⑧⑨⑩ and connectors ⑪.

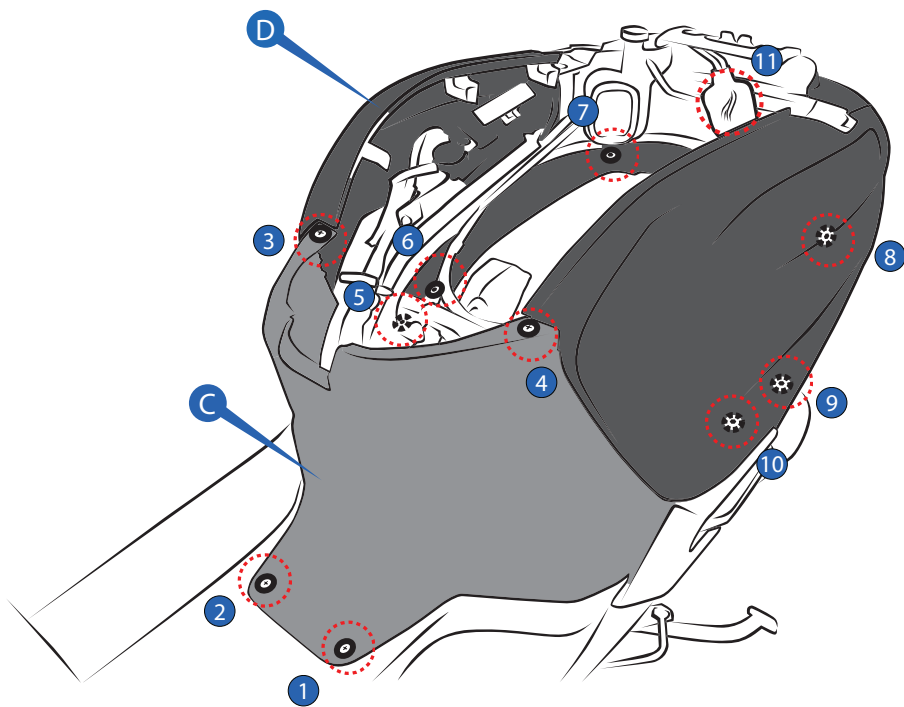

MOUNTING INSTRUCTIONS

5

Remove the rear fender **E** by loosening the screws **1** **2** **3** **4**.

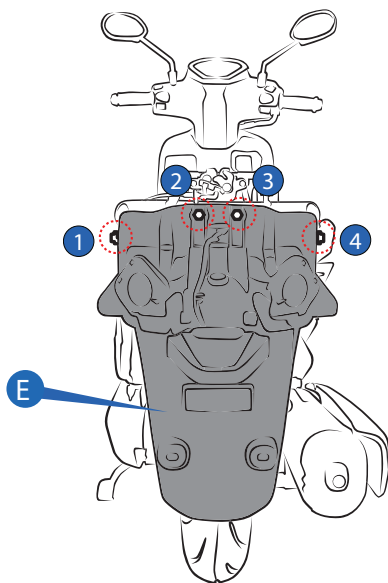

6

Remove the standard shock absorber **F** by loosening the upper and lower mounting bolts **5** **6**.

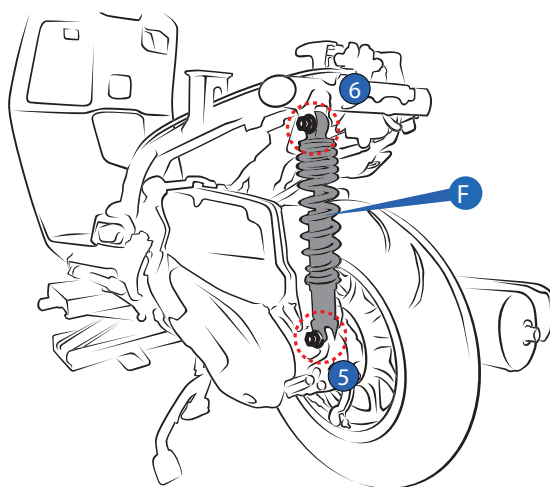

MOUNTING INSTRUCTIONS

7

Remove the sensor cover screw **G** and replace it with the Öhlins parts as diagram 1. This modification is needed for improving the clearances between the sensor cover and the Öhlins shock absorber.

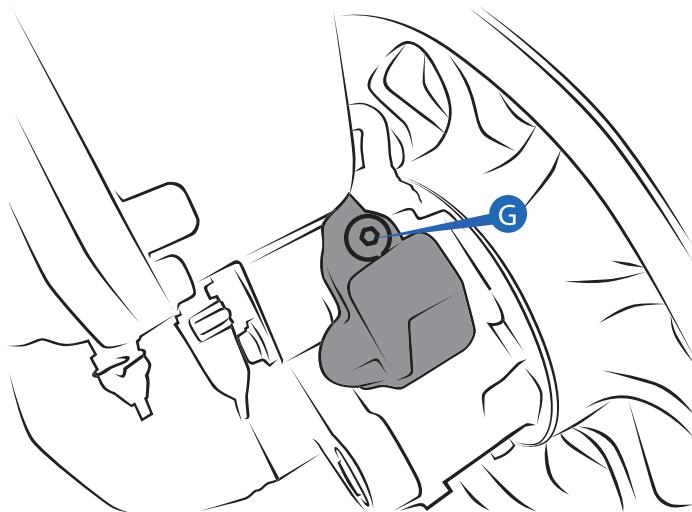
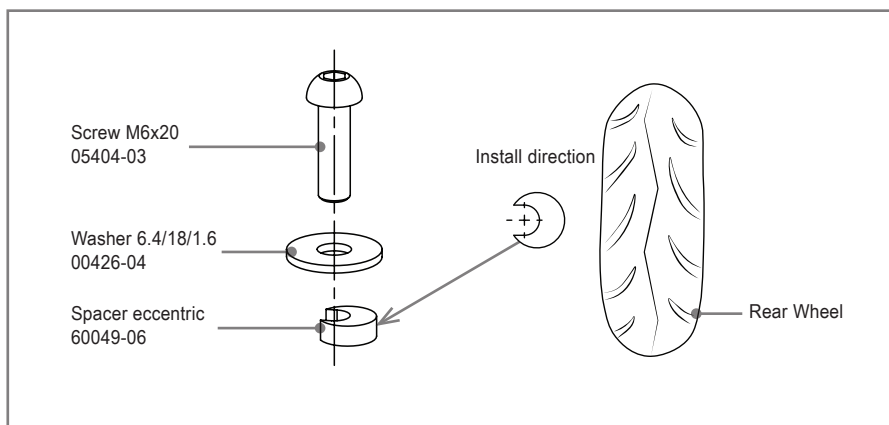

Diagram 1



MOUNTING INSTRUCTIONS

8

Install the Öhlins shock absorber by tightening the upper and lower mounting bolts ①② at a torque value as specified in the vehicle service manual. Reverse all the procedures as necessary.

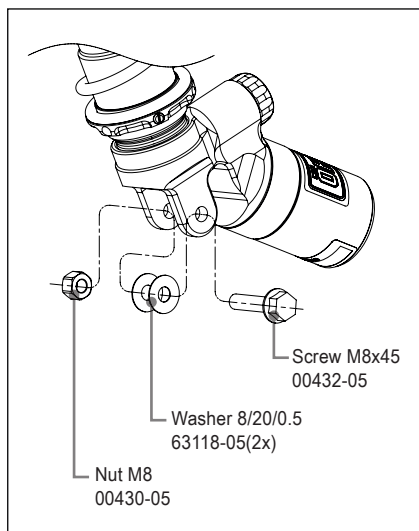
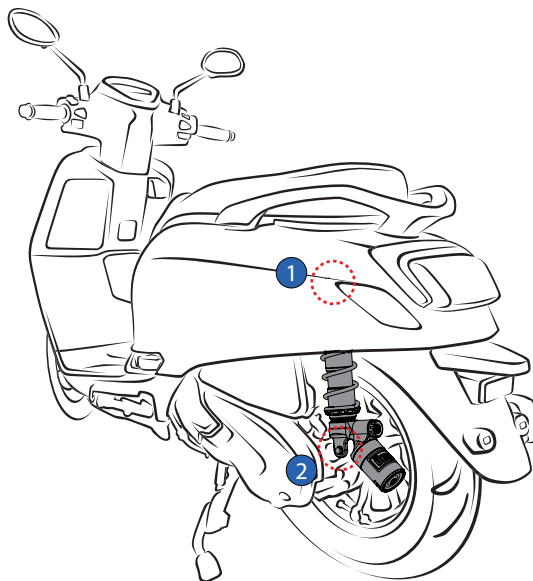

Note!

Lower the vehicle so that the suspension is slightly compressed before tightening the screws.

Caution!

Ensure that all screws are tightened to the correct torque and that nothing fouls or restricts movement of the shock absorber when the suspension is fully compressed or extended.

ADJUSTMENTS

Warning!

Before riding, always make sure that the basic settings made by Öhlins are according to recommended Set-up Data. Read about adjustments and setting up in the Öhlins Owner's Manual before you make any adjustments. Contact an Öhlins dealer if you have any questions about setting up.

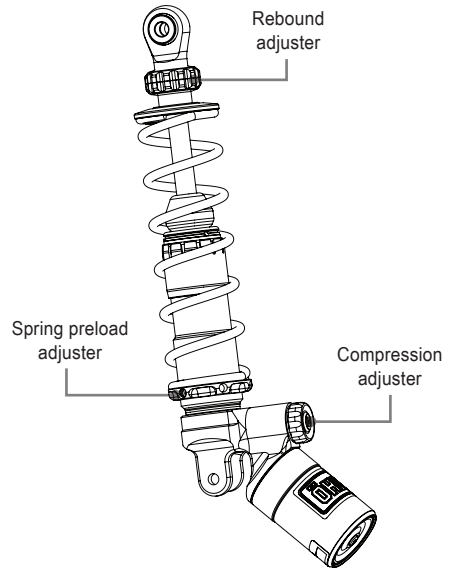

SET-UP DATA

Recommended set-up

Spring Preload 3 mm
Compression adjuster 16 Clicks
Rebound adjuster 18 Clicks

Shock absorber data

Length 319.5 mm
Stroke 82.5 mm

Spring data Installed spring

Part No 60001-02
Free spring length ... 195 mm
Spring rate Prog. 25-45 N/mm
Preload adj.range ... [0-10] mm

 Öhlins products are subject to continuous improvement and development, therefore, although these instructions include the most up-to-date information available at the time of printing, minor updates may occur.

To find the latest information contact an Öhlins distributor. Please contact Öhlins if you have any questions regarding the contents in this document.

Part no. MI_HO 349_EN_0
Issued 2023-11-30

© Öhlins Asia Co. Ltd. All rights reserved. Any reprinting or unauthorized use without the written permission of Öhlins Racing AB is prohibited.

Öhlins Asia Co. Ltd
700/937 Moo5, Tambol Nongkhaga,
Amphur Phantong, Chonburi Province
20160 Thailand



www.ohlins.com