

Note!

Please note that this image is a general representation of the product and may differ slightly from your product.

Note!

Please note that during storage and transportation, especially at high ambient temperature, some of the oil and grease used for assembling may leak and stain the packaging. This is in no way detrimental to the product, wipe off the excessive oil/grease with a cloth.

Note!

Before installing this product, check the contents of the kit. If anything is missing, please check an Öhlins dealer.

Kit Contents

Description	Part No	Pcs
Shock absorber	HO 345	2
Spacer 10x11.5	01218-19	2
Spacer 10x8	01218-42	2
Spacer 10x9	01218-58	4
Seal ball joint	00534-01	4
Screw M8x35	00432-01	2
Tool preload adjuster	03199-03	1
Sticker set "ÖHLINS"	10207-01	1
Owners manual	07241-02	1

Alternative spring		
Spring	60480-11	2

Warning!

Before installing this product, read the Öhlins Owner's Manual. The shock absorber is an important part of your vehicle and will affect the stability.

Shock Absorber for Honda ADV160/150

HO 345

Mounting Instructions

MOUNTING INSTRUCTIONS

⚠ Warning!

It is advisable to have an Öhlins dealer install the shock absorber.

⚠ Warning!

If working on a raised vehicle, ensure it is securely supported so that it will not tip over.

⚠ Warning!

Install spacer according to owner bike model first before perform any installation process.

👁 Note!

Before mounting this product clean the vehicle thoroughly.

👁 Note!

When working on this product, always see the Vehicle Service Manual for vehicle specific procedures and important data.

⚠ Spacer mounting pattern ⚠

ADV 160

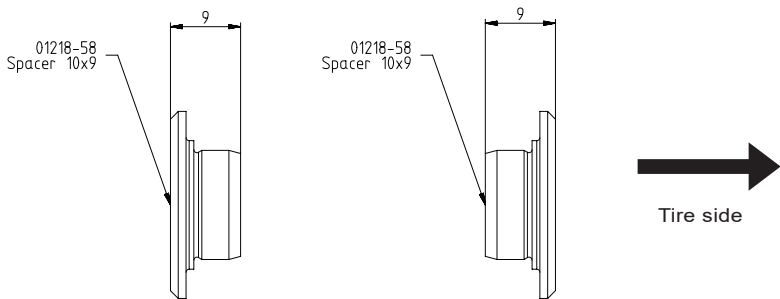

ADV 150

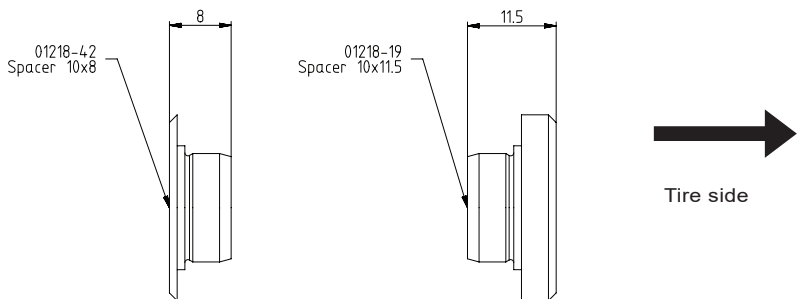

MOUNTING INSTRUCTIONS

Mounting Instructions for ADV 160

1.
Put the motorcycle on a work stand so that the rear wheel barely touches the ground. Make sure the motorcycle is in a stable position.
2.
Open the seat by the ignition key.

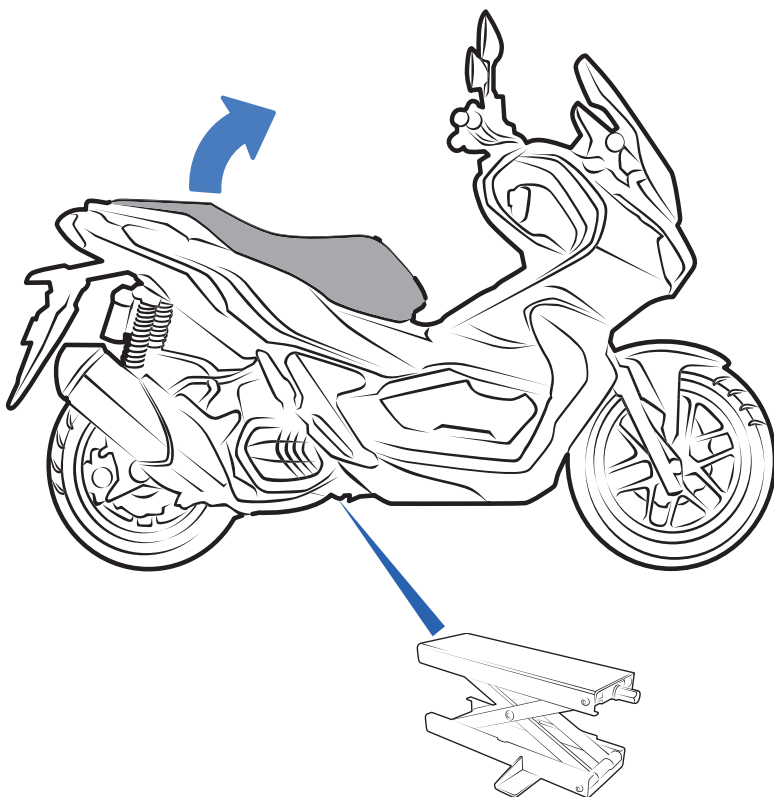

MOUNTING INSTRUCTIONS

3.

Remove screws ①②③④ show in picture below.(Upper mounting bolt locate inside side fairing)

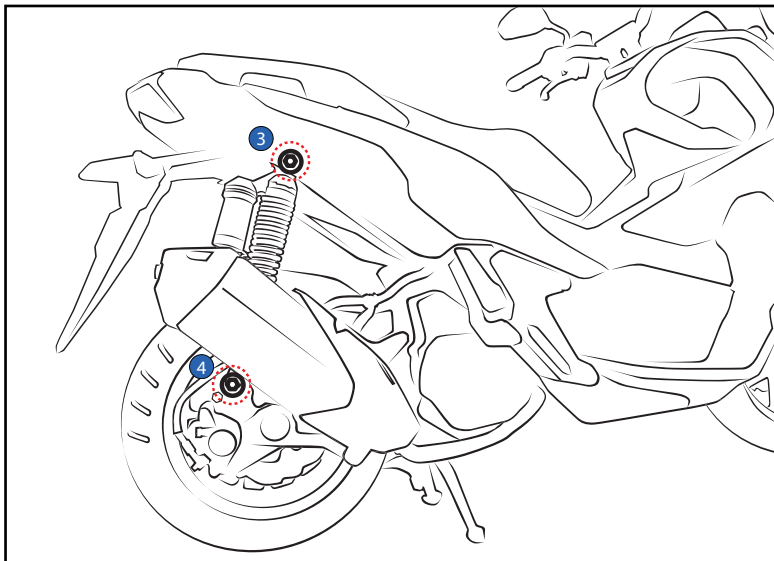
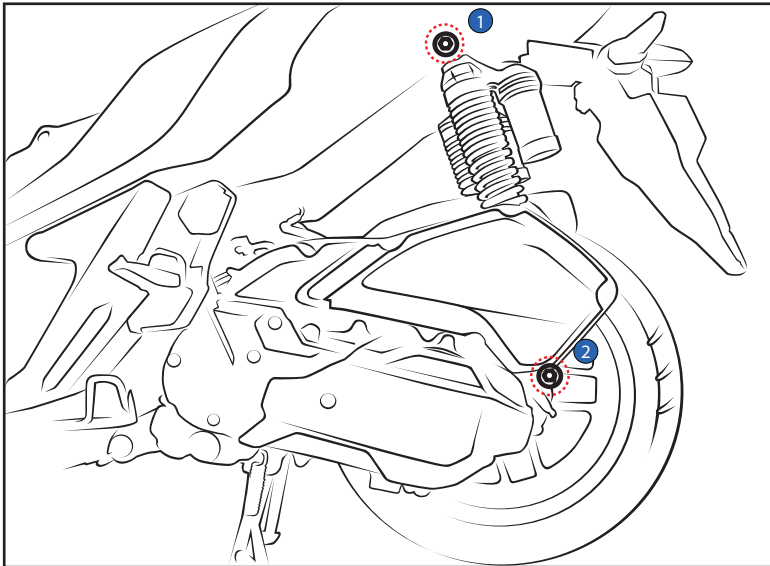

MOUNTING INSTRUCTIONS

4.

Remove stock shock absorber and replace with ohlins shock absorber HO 345 with spacer 01218-58

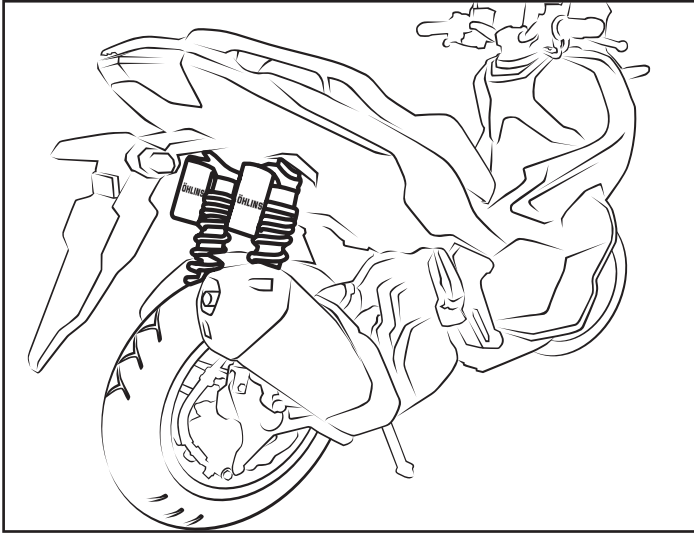

Note!

Lower the vehicle so that the suspension is slightly compressed before tightening the screws.

Caution!

Ensure that all screws are tightened to the correct torque and that nothing fouls or restricts movement of the shock absorber when the suspension is fully compressed or extended.

MOUNTING INSTRUCTIONS

Mounting Instructions for ADV 150

1

Put the motorcycle on a work stand so that the rear wheel barely touches the ground. Make sure the motorcycle is in a stable position.

2

Open the seat by the ignition key.

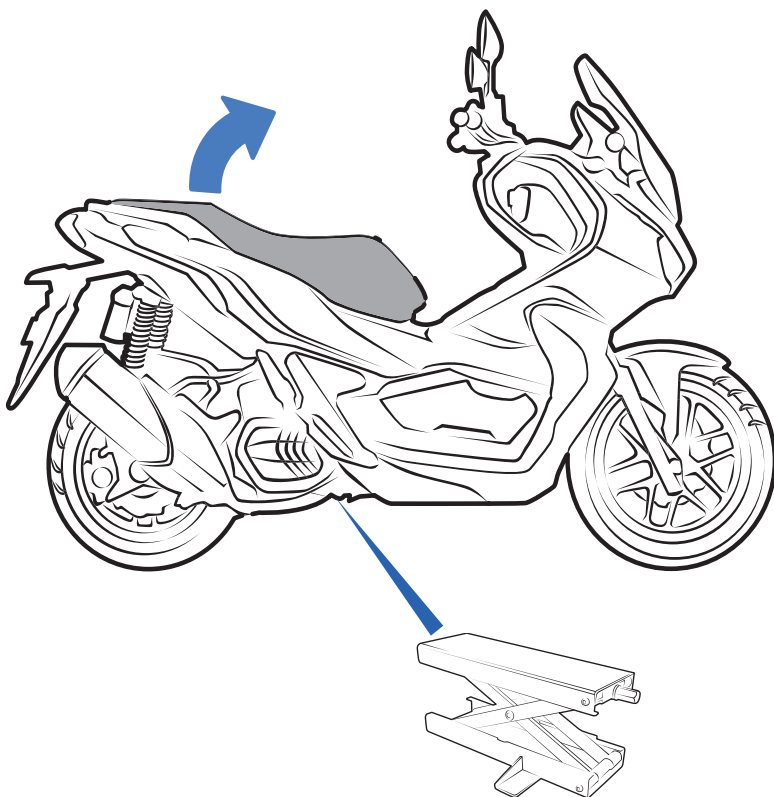

MOUNTING INSTRUCTIONS

3

Remove the grab bar (A) by loosening the screws ①②③④

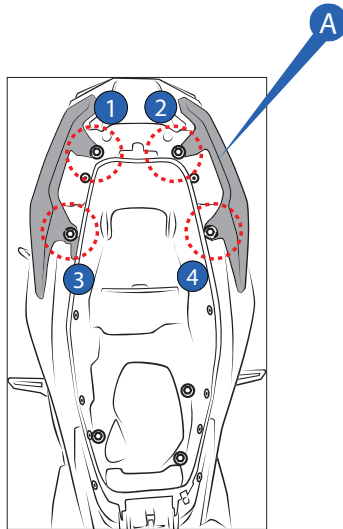

4. Remove the storage box (B) as per following instructions;

4.1 Loosening the screws ①②③④⑤

4.2 Unlock the plastic clip locks ⑥⑦⑧⑨⑩⑪⑫⑬

4.3 Remove the battery plastic cover (C)

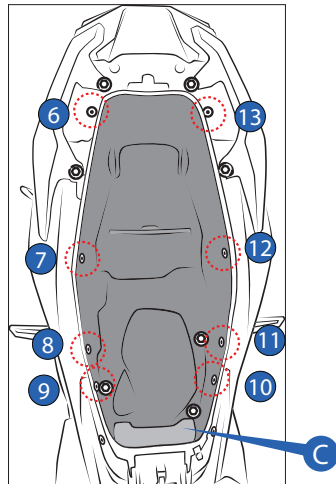
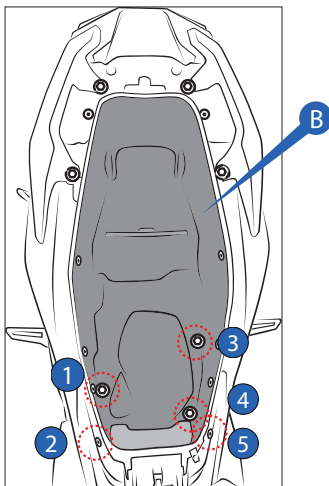

MOUNTING INSTRUCTIONS

4.4 Loosen the screws ① ② and then release the rubber band ④ that holds the battery.

4.5 Loosen the screw ③ and remove the entire storage box ⑤

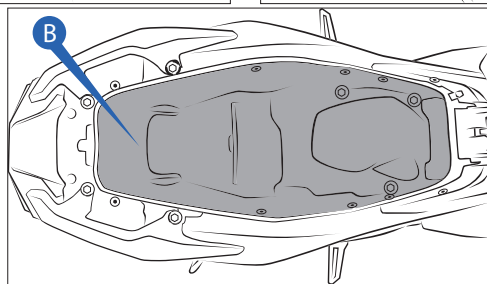
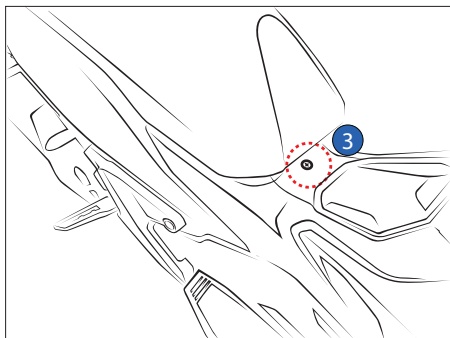
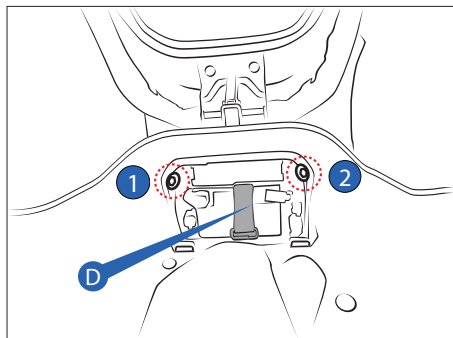

5. Remove the tail light plastic cover ⑤ by loosening the screws ① ② ③ ④

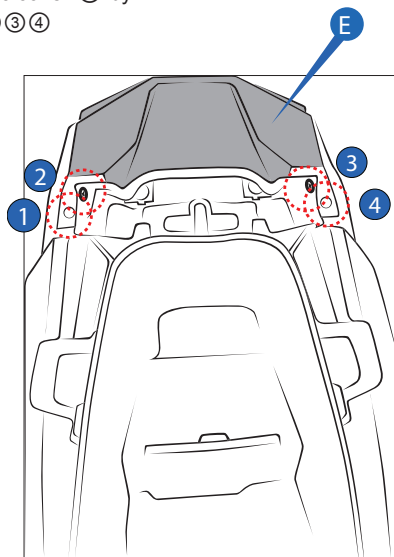

MOUNTING INSTRUCTIONS

6.

Remove the plastic cover **F** by loosening the screws **1** **2** in order to access the airbox mounting screws which are located underneath.

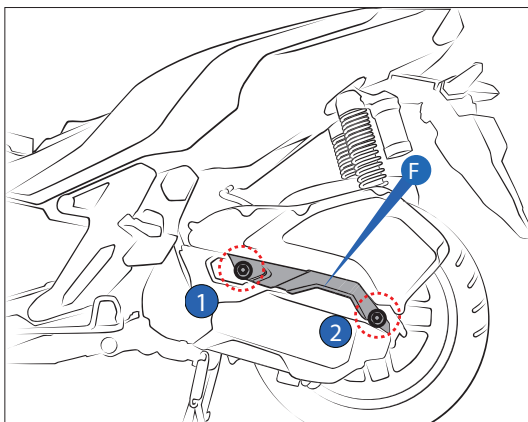

7.

On the left side : Release the airbox **G** by loosening the screws **1** in order to access to the shock absorber lower mounting screw.

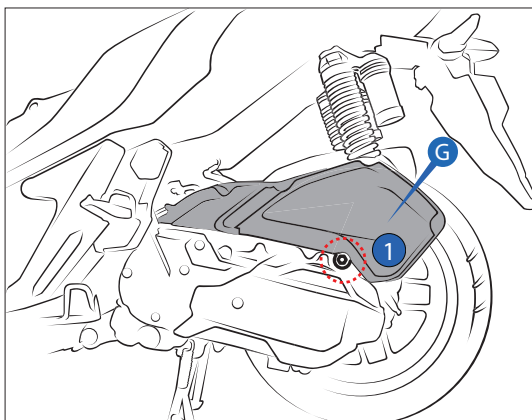

MOUNTING INSTRUCTIONS

8.

On the right side : Release the brake line holding bracket (H) by loosening the screw (1) in order to access to the shock absorber lower mounting screw.

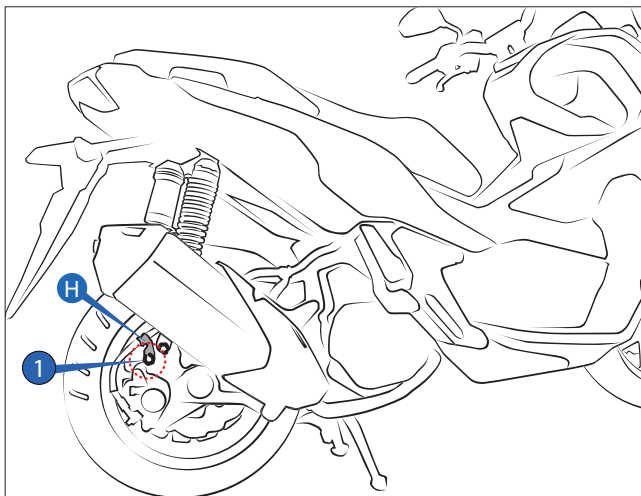

9.

Remove the standard shock absorber by loosening the upper mounting nuts (1) and the lower mounting screws (2)

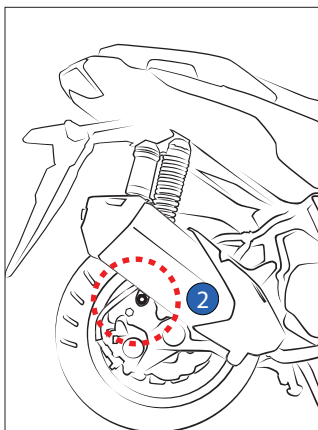
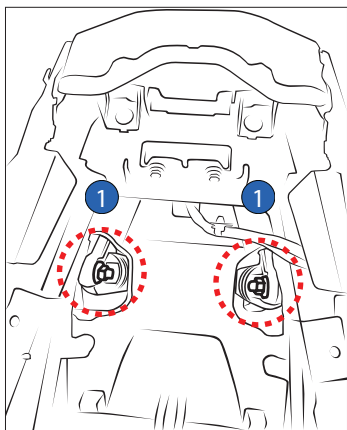

MOUNTING INSTRUCTIONS

10.

Install the Öhlins shock absorber according to diagram P1

Tighten the upper mounting nuts ① and the lower mounting screws ② at a torque value as specified in the vehicle service manual.

Reverse all the procedures as necessary.

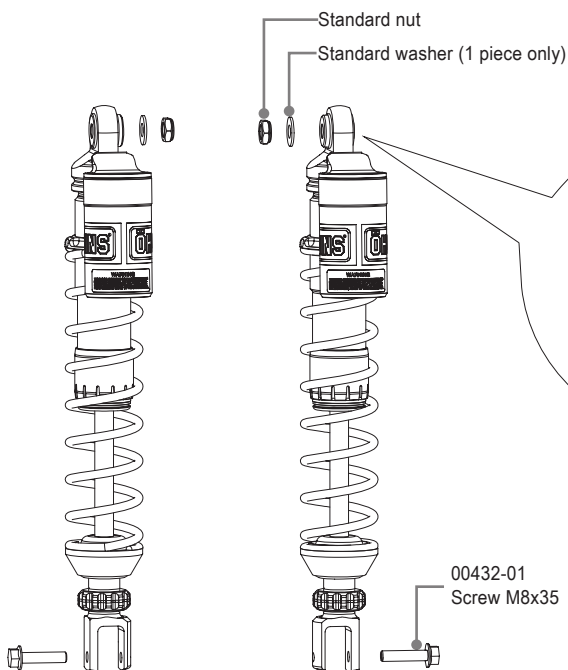
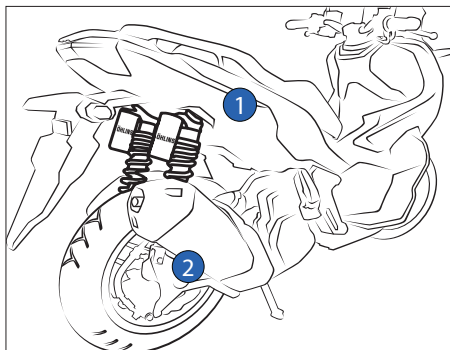

Left side

Right side

P1

👁 Note!

Lower the vehicle so that the suspension is slightly compressed before tightening the screws.

👋 Caution!

Ensure that all screws are tightened to the correct torque and that nothing fouls or restricts movement of the shock absorber when the suspension is fully compressed or extended.

ADJUSTMENTS

⚠ Warning!

Before riding, always make sure that the basic settings made by Öhlins are according to recommended Set-up Data. Read about adjustments and setting up in the Öhlins Owner's Manual before you make any adjustments. Contact an Öhlins dealer if you have any questions about setting up.

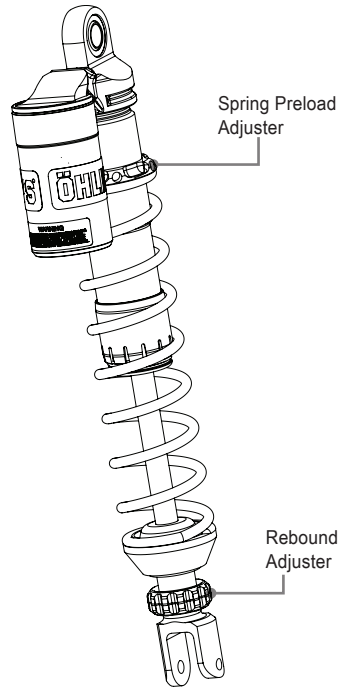

SET-UP DATA

Recommended set-up

Spring Preload..... 3 mm.
 Rebound adjuster 22 Clicks

Shock absorber data

Length 397.5 mm.
 Stroke 121.5 mm.

Spring	Installed spring (Medium)	Alternative spring (Hard)
Part No	60480-01	60480-11
Free spring length...	230 mm	230 mm
Spring rate.....	Prog 10-14 N/mm	Prog 15-25 N/mm
Preload adj.range....	[0-7] mm	[0-10] mm

Ⓞ Öhlins products are subject to continuous improvement and development, therefore, although these instructions include the most up-to-date information available at the time of printing, minor updates may occur.

To find the latest information contact an Öhlins distributor. Please contact Öhlins if you have any questions regarding the contents in this document.

Part no. MI_HO 345_EN_0
 Issued 2023-07-11

© Öhlins Asia Co. Ltd. All rights reserved. Any reprinting or unauthorized use without the written permission of Öhlins Racing AB is prohibited.

Öhlins Asia Co. Ltd
 700/937 Moo5, Tambol Nongkhaga,
 Amphur Phantong, Chonburi Province
 20160 Thailand



www.ohlins.com